

User Manual: EPIG®



Contents

1. About this User Manual.....	4
2. Transport and storage	4
3. General safety advice for operating and cleaning.....	4
4. General description and information.....	5
4.1. Description	5
4.2. Packaging contents.....	5
4.3. Operating requirements.....	5
4.4. Target species.....	5

4.5.	Mode of action	6
4.6.	Included and optional accessories	7
5.	Bottle connection / disconnection	8
5.1.	Bottle Collar.....	8
5.2.	Click-in Bottle Mount:	9
5.3.	Tubing Collar.....	10
6.	Device Start	11
7.	User Menu	11
8.	Sensors	14
8.1.	Position Sensor.....	14
8.2.	Air Detection Sensor.....	14
8.3.	Nozzle Sensor	14
9.	Vaccination Process.....	15
10.	Device Cleaning	17
10.1.	Rinsing	17
10.2.	Cleaning of the device	17
11.	Troubleshooting	18
12.	Maintenance and Repair	20
12.1.	Cylinder Service	20
12.2.	EPIG® App	23
12.3.	Maintenance and repair service.....	23
13.	Dismantling.....	24
14.	The battery and the charger.....	25
14.1.	Battery	25
14.2.	Charger	25
15.	Technical Specifications.....	27
16.	Disposal	27
17.	EC declaration.....	28

EPIG® User Manual

This user manual is part of the EPIG® injector and an important part of the safe usage concept.



- Read the user manual carefully and follow the instructions –

© copyright · Henke-Sass, Wolf GmbH · 8300052134 – 01/22 · Subject to amendments in technology and design · Printed in Germany



The EPIG® injector is manufactured by:

Henke-Sass, Wolf GmbH
Keltenstrasse 1
78532 Tuttlingen
Germany

Tel. +49 74 62 94 66 207
Fax +49 74 62 94 66 52 08
www.henkesasswolf.de
E-mail: info@henkesasswolf.de

1. About this User Manual

While reading the user manual you will see that it includes warning signs, to alert you to risks arising from incorrect usage of the product that could result in death, injuries or material damage. Always take careful note of these warnings! The warning signs are highlighted as shown on the right.



2. Transport and storage

Protect the product against external forces (e.g. impacts, shocks and knocks) during transport
Check the EPIG® injector for any transport damage before use.















Transport and/or store the EPIG® injector in its original packing.

Store the EPIG® injector so that it is protected from sunlight.

Do not store the batteries at temperatures lower than 5°C.

Never store the EPIG® injector in a wet or humid condition (e.g. directly after cleaning).

3. General safety advice for operating and cleaning

-  Direct contact between the vaccine and/or rinsing fluid and the eyes and/or respiratory tract of the operator can be harmful. In these cases, seek immediate medical advice and show the vaccine information sheet.
-  Use the EPIG® device for vaccinating **piglets only (around weaning until end of nursery)** with conventional vaccines.
-  Keep children out of the operating area.
-  **Do not immerse the EPIG® device in any liquid.**
-  **Do not autoclave the EPIG® device.**
-  **Do not sterilize the EPIG® device in an UV box, nor any other sterilization device (i.e. EO-sterilization or gamma radiation).**
-  Do **not** point the EPIG® device towards any part of your body or towards other people! In case of accidental injection of vaccine and/or rinsing fluid, seek immediate medical advice and show the vaccine information sheet.
-  Beware of the spike in the bottle holder. It may contain residues of the vaccine and/or rinsing fluid. In case of a spike wound, seek immediate medical advice and show the vaccine information sheet.
-  Do **not** operate the safety cylinder around the injection heads with your hand when starting, vaccinating or cleaning.
-  If the safety cylinders are pressed when fingers or any other part of the body are in front of the injection heads, there is a danger of accidental self-injection with vaccine or rinsing fluid. Seek immediate medical advice and show the vaccine information sheet.
-  Wear safety goggles and a mask when using the EPIG® device. Ensure goggles are clean for optimal vision.
-  Wear rubber gloves when cleaning the EPIG® device.
-  Do not throw the battery into water. Protect the battery from water and humidity, which could cause it to leak and release hazardous substances.
-  Do not throw the battery into fire, nor heat the battery. It may explode and/or release hazardous substances.

- ⚠ Do not expose the battery to temperatures higher than 60°C. It may explode and/or release hazardous substances.
- ⚠ Only veterinary practitioners or operators instructed by an experienced EPIG® user are permitted to work with the EPIG® device and vaccines.
- ⚠ Dropping the device while it is loaded with liquid may cause an unintended release.
- ⚠ To prevent leakage, reduce the pressure inside the bottles by piercing them with a sterile needle prior to mounting a bottle on the device. Hold the EPIG® device upside down when mounting a new bottle.
- ⚠ Releasing the trigger of the EPIG® device will immediately switch off all controls, making it impossible to give an injection.
- ⚠ When expelling residual vaccine or rinsing fluid from the device, always position the injection nozzles on a cloth in a receptacle placed on a firm base. Never inject into the air.
- ⚠ If the safety cylinders remain jammed around the injection nozzles after firing, immediately release the trigger of the EPIG® device and contact your supplier.
- ⚠ Operating the EPIG® device for a longer period of time may induce cramps in the operator's hands. Regular breaks are recommended.

4. General description and information

4.1. Description

EPIG® is intended for the needle-free intra-muscular vaccination of piglets with either 1ml or 2ml volume.

4.2. Packaging contents

- EPIG® device (1)
- Spare cylinder (2)
- Two batteries (3)
- Battery charger (incl. international socket adaptors) (4)
- PET bottle for use with defined cleaning liquids (5)
- Universal bottle collars (Ø20mm & Ø30mm) & Click-in Bottle Mount (6)
- Tubing adaptor (7) + Tubing (under the device)
- Threaded bottle collar for use with PET bottle (8)
- Lubricant for cylinder service (10ml white oil) (9)
- Wrist strap + basket (10)
- Cylinder assembly tool (11)



Note: Before using EPIG® for the first time, charge the batteries in the battery charger. Please read chapter 14 on how to optimize the lifetime and durability of the batteries.

4.3. Operating requirements

Please read the user manual carefully before first use.

4.4. Target species

EPIG® should **only be used for vaccinating piglets around weaning until end of nursery**. It must not be used on younger piglets before weaning or older pigs, breeding animals (sows, boars) or in other species. Testing an injection with the EPIG® device should only be performed on an appropriate surface, such as a sponge or a thick cloth in a receptacle.

4.5. Mode of action

EPIG® has a bottle holder equipped with a draw-off spike, on which bottles can be mounted. Vaccination takes place through the injection head (E). The injection head is fitted with a mechanical safety cylinder.

A pen counter, day counter, total counter and a service counter are integrated in the EPIG® device. The two buttons underneath the screen (B) operate its display. The LED bars (H) on each side of the device are an optical indicator for every action that is carried out during the vaccination process (see chapter 9).

The EPIG® device comes with two batteries and a battery charger. Before use, insert a charged battery into the base of the EPIG® device (D).

Operation of the EPIG® begins with inserting a bottle of vaccine into the bottle holder (A) and pushing the trigger (F) to activate the injector. This will start the pump and vaccine is automatically drawn out of the bottle. The rinsing fluid, which is present inside the tube during storage, is pumped out of the tubes via the injection head.

The device comes with an eyelet (C) to mount a shoulder strap as well as a slot (G) for the wrist strap supplied.

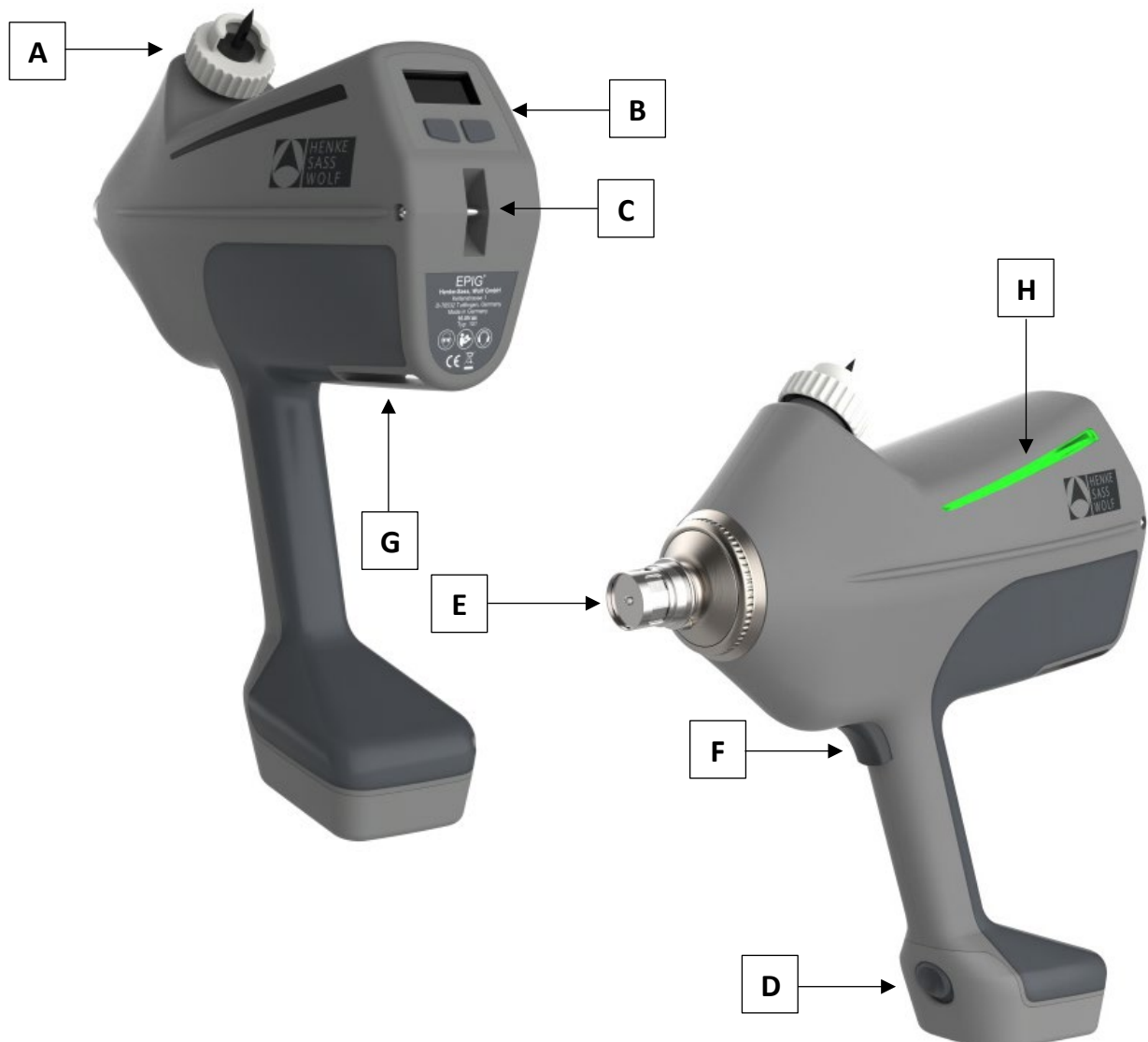

4.6. Included and optional accessories

Included:

- Wrist strap:
 - a) Place the flap of the shorter Velcro band around your wrist so that the closure is below the palm of your hand and close it with light pressure.
 - b) Twist the wrist strap around your wrist until the beginning of the long Velcro strap is on the downside of your wrist (hand held as shown in the picture).
 - c) Take the prepared device (see chapter 5) without pulling the trigger(!) and push the long Velcro strip through the slot, at the back of the EPIG® device, so that the Velcro side faces your wrist.
 - d) After the strap is pushed through the opening, pull the strap until your wrist rests against the device. Place the Velcro strap around the outer side of your wrist as far as possible and secure it with the Velcro strap.

Caution: Please ensure that the wrist band or Velcro strap is not pulled to tight around the wrist, so that the blood circulation to the hand is not interrupted.

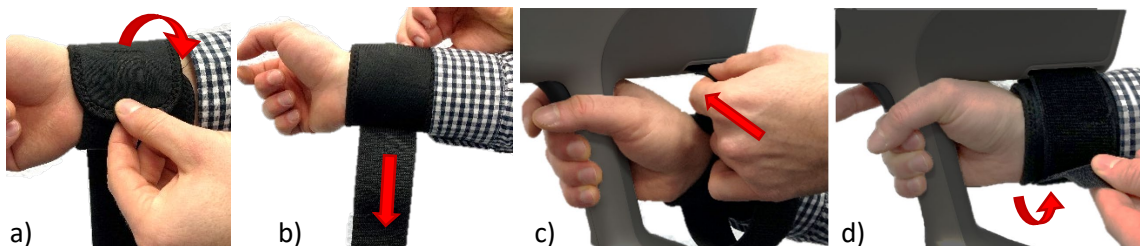

Optional:

- Shoulder strap (see chapter 4.5)
- Stationary mounting device:
This device enables operators who prefer to perform vaccination by lifting the piglets up, to work independent. For that the EPIG® has to be installed into the stationary mount, which in turn is attached to pen walls. After the stationary mode is activated (see chapter 7) the piglet's neck is held against the EPIG® device with light double pressure to activate the trigger mechanism. Detailed information about the stationary mounting device is provided on the Website and is included in the scope of delivery when ordered.

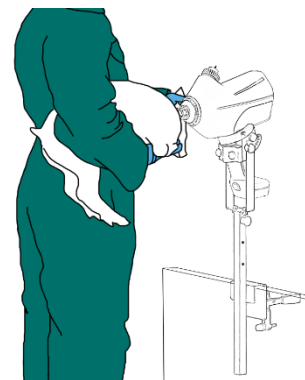

- For the accessories (i.e. bottles of different sizes, draw-off caps, etc.) please contact Henke-Sass, Wolf.

5. Bottle connection / disconnection

Prior to inserting the battery, connect a bottle (vial) of vaccine or rinsing fluid (see chapter 9 “Device Cleaning”) to the device by following these steps:

5.1. Bottle Collar



a. Place the device in the recommended position as indicated in the picture on the left.



b. Unscrew the bottle collar (white adaptor on the picture) from the bottle mount spike.

CAUTION: The spike is very sharp as it has to puncture the stopper of a vaccine bottle. Please avoid unintended contact with the tip of the spike.



c. Attach the bottle collar to the bottle as shown on the picture.



d. Pre-puncture the stopper of the vaccine bottle centrally with a sterile needle to avoid rubber particles being drawn into the spike of the vaccination device and eliminate the overpressure inside the bottle. Place the injector on a solid surface (as shown on the first picture) and push the bottle onto the spike using the pre-punctured hole.

CAUTION: Without pre-puncturing of the bottle stopper, rubber particles may be drawn into the device, leading to potential dysfunction by blocked valves and / or nozzle.



e. Connect the bottle to the device by screwing the collar onto the thread (clockwise) until it is tight. Please make sure to twist only the white collar, not the bottle itself. After completion of this step, check if the bottle sits tightly.



f. Turn the injector back into an upright position. Insert the battery at the bottom of the handle. This step will activate the device.

To disconnect a bottle from the device, proceed in the reverse order. Always make sure to have the draw-off spike of the device pointing downwards when connecting or disconnecting a bottle. Otherwise, vaccine will be spilled over the device while a bottle is being connected to or disconnected from the bottle mount.

5.2. Click-in Bottle Mount:



a. Place the device in the recommended position as indicated in the picture on the left.



b. Unscrew the bottle collar (white adaptor on the picture) from the bottle mount spike.

CAUTION: The spike is very sharp as it has to puncture the stopper of a vaccine bottle. Please avoid unintended contact with the tip of the spike.



c. Attach the Click-in Bottle Mount to the bottle mount spike and fixate it with the basket by screwing it to the bottle attachment.



d. Pre-puncture the stopper of the vaccine bottle centrally with a sterile needle to avoid rubber particles being drawn into the spike of the vaccination device and eliminate the overpressure inside the bottle. Place the injector on a solid surface (as shown on the picture) and push the bottle onto the spike using the pre-punctured hole until the bottle sits firmly.

CAUTION: Without pre-puncturing of the bottle stopper, rubber particles may be drawn into the device, leading to potential dysfunction by blocked valves and / or nozzle.



e. Turn the injector back into an upright position. Insert the battery at the bottom of the handle. This step will activate the device.

To disconnect a bottle from the device, proceed in the reverse order. Always make sure to have the draw-off spike of the device pointing downwards when connecting or disconnecting a bottle. Otherwise, vaccine will be spilled over the device while a bottle is being connected to or disconnected from the bottle mount.

5.3. Tubing Collar

If using the tubing collar to connect a larger bottle via tubing, **prefill the tubing (!)** prior to attaching it to the tubing collar. Prefilling the tubing can help to prevent the formation of air bubbles in the system. The tubing adaptor for the bottle is not included in the EPIG[®] packaging but can be ordered as an accessory from Henke-Sass, Wolf.

When the tube starts to fill, kink the tube just before the end to prevent loss of vaccine. Then quickly connect the tubing to the adaptor. You can now insert the battery at the bottom of the handle. This step will activate the device.



6. Device Start

Once the vaccine bottle is connected, insert the battery and the device will turn on, showing both the Henke-Sass, Wolf and the EPIG® logos on the display. Both logos are shown for 1 second.

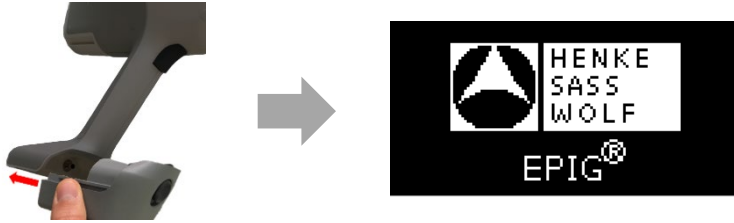

If the battery is sufficiently charged: The display will switch initially to the User Menu, unless the device is in a loaded condition (cylinder filled with vaccine / rinsing fluid) – in which case the display will show “! Loaded Device ! Press any button” and the LED bars flashes red. To avoid the unintentional loading of the device, do not push the trigger if you do not intend to inject a vaccine dose, and do not store or turn the device off while loaded.

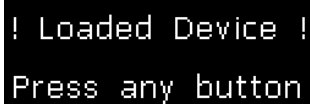

By pushing one of the display buttons, the device will rinse once, to unload the device. The liquid will be sprayed out through the injection head. Do not point the injection head of the device at yourself or other people while unloading the device.

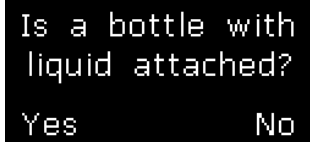

If the Device is not loaded the display will show the question “Is a bottle with liquid attached?”. If a bottle with vaccine is connected to the device, push the left button. If not, push the right button to continue without a vaccine. In this case, it is not possible to start a vaccination process or draw fluid by pulling the trigger.

Afterwards, the device will switch to the home screen of the User Menu (see chapter 7).

Before pushing the trigger for the first time, make your settings in the User Menu.

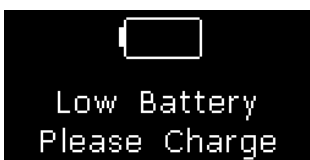

If the battery is too low: The display will show “Low Battery Please Charge”.

7. User Menu

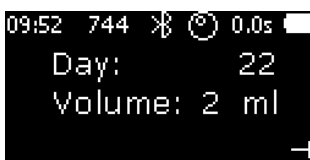

The home screen of the User Menu will show the most relevant information in its middle, like day counter and currently set volume. Furthermore, the start display shows at the top edge, from left to right: time, pen counter, Bluetooth, activated sensors, selected delay and battery level.

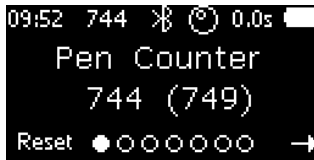

To proceed to the menu pages push the right button. To get back to the home screen you have to navigate through the menu pages by pushing the right button.

The dots at the bottom of the screen indicate the current menu page. On the first page of the user menu, the Pen Counter is shown. The first number indicates the amount of successful vaccinations of the pen, the second number in parentheses indicates the number of all shots performed in the pen, including the early releases. To reset this pen counter, push and hold the left display button for two (2) seconds.

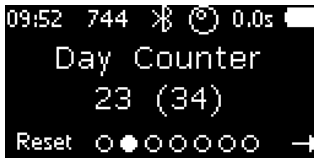

On the second page, the Day Counter is shown. Again, the first number indicates the number of successful vaccinations for the day and the second number in parentheses indicates the number of all shots performed during the day, including the early releases. To reset the day counter, push and hold the left display button for two (2) seconds.



On the third page, the volume can be adjusted. The currently set volume is shown in the middle, the optional volume is shown on the lower left side. Push the left display button to choose the optional volume. The dose will be changed only upon usage of the device (after the priming cycles and before the first injection). The display will show the information "Changing Volume for vaccination" and flash yellow. After the information disappeared vaccination can be started.

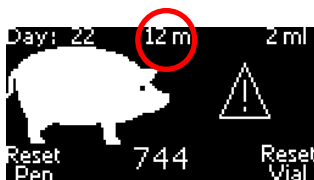

On the fourth page, the Vial level indicator can be controlled. This indicator will give an optical warning (via yellow LED bars and warning sign between piglets on the display) once you have used 90% of the vaccine inside the connected bottle. When this warning appears, you have 10% left inside the bottle that is mounted to the EPIG® device. This allows for a better overview on when to change a bottle during the vaccination session. To activate the vial level indicator, choose the size of the bottle / canister you want to mount by pushing the left display button (0ml, 20-50ml (intervals of 5), 50-500ml (intervals of 50) and 500-5000ml (intervals of 500). All bottle sizes above 200ml ideally being connected via tubing unless working with the stationary mount.)

CAUTION: The vial level indicator is a simple counter that needs to be set up according to the bottle size mounted to the device. It counts backwards from the set volume to zero, the current counter reading is shown in the top center of the display.



The fifth page shows the Service Counter, which is counting from 12,000 to 0. If the value falls below 0, the counter continues counting negatively. Push and hold the left display button for two (2) seconds to reset the service counter. Attention: Do not reset the counter until the cylinder service with cylinder change has been performed.

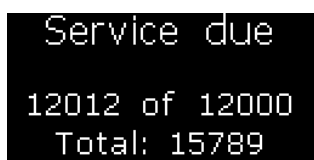

A 'Service due' message appears after there have been 12,000 or more injections, showing that a cylinder service needs to be performed (see chapter 11.1).



The sixth page shows the Total Counter, which counts the total number of injections. This counter cannot be reset as it is a key indicator of the age of the device.

Submenu “Settings”:



On the first page of the submenu, the Position Sensor can be controlled. Push the left display button to disable or enable the position sensor. Recommended setting is “Position Sensor enabled”. (Disabling is only recommended when using the tubing adaptor supplied with the device and having vaccine delivered via tubing.) For further details, see chapter 8 “Sensors”.

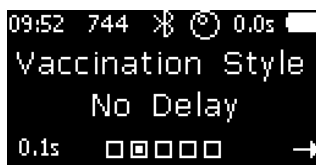

On the second page, the Vaccination Style can be selected. Default vaccination style is “No Delay”, which is for lifting / presenting the piglets to a second person who is vaccinating them with minimum time lapse between applying the device to the skin of the piglet and the injection itself.

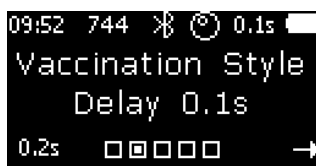

Push and hold the left display button to select the alternative setting “Delays”, which offers vaccination of the piglets by only one person and leaving the piglets on the floor during injection. If vaccinating on the floor, a preferred time between skin contact and injection can be selected, to enable the worker to ensure proper contact between the device and the piglet before the injection is released. The device offers settings from 0.1s to 0.5s by tenths.

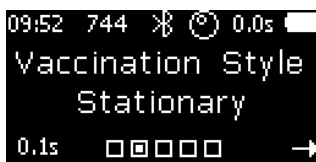

The mode “stationary” is for the use of the device in combination with the stationary station (see chapter 4.6).



On the third page, Bluetooth can be controlled. Push the left display button to disable or enable the Bluetooth antenna. If using the EPIG® App, enabled Bluetooth is required.

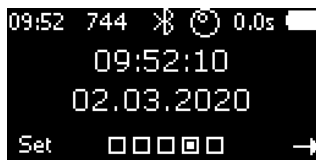

The fourth page shows date and clock. The format of the clock is hh:mm:ss and the format of the date is dd.mm.yyyy. By pushing the left display button, you can set the date and clock.

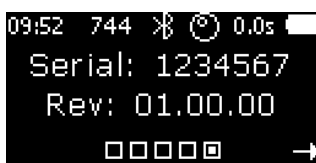

On the last page, the serial number (PT1.0x) and the software version is shown. Push the right display button to return to the “Settings” page of the user menu. Push the right display button again to reach the home screen of the user menu.

8. Sensors

The EPIG® device is equipped with several sensors to guarantee an optimal vaccination result.

8.1. Position Sensor

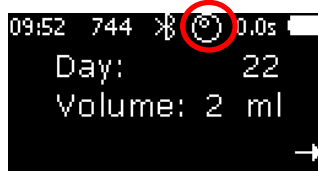

This sensor allows for continuous control of the correct holding position of the device (see picture on the left). Once the trigger has been pushed, before allowing liquid to be drawn into the device the position sensor will check if it is held upright in order to avoid drawing in air.



If the device is held in the correct angle (see picture on the left), which is indicated by the small circle being inside the big circle, liquid from the attached bottle will be drawn in.



Please do not move the device out of its vertical position (see picture on the left) until it is fully loaded (white LEDs are flashing).

Once the device is fully loaded with liquid, the holding position is no longer relevant until the trigger is activated again.

Please note: When using the tubing adaptor to deliver vaccine, no position sensor reading is needed because there is no bottle mounted on top of the device. In this case, the position sensor can be disabled (*user menu* → *settings* → *position sensor* → *disabled*).

8.2. Air Detection Sensor

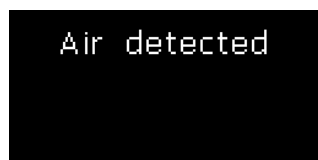

This sensor measures whether fluid or air is drawn into the device. If air is drawn in, e.g. by emptying the bottle and not fitting a new one in time, a warning “Air detected” is shown. Afterwards, only rinsing is possible, indicated by blue flashing LED bars, until the air exits at the injection head. This takes a minimum of 3 rinsing cycles, as the liquid circuit has a volume of a little less than 6 ml and one rinsing cycle moves a volume of 2 ml. After the rinsing process, you will be able to vaccinate again (indicated by white flashing LED bars).

8.3. Nozzle Sensor

This sensor enables an extra safety precaution when using the injector. Once the EPIG® device is ready for vaccination (white flashing LED bars), push and hold the trigger. When the device is applied to the skin of the piglet, the safety sleeve around the injection head will slide back, releasing the vaccine. If either the trigger is not pushed or the safety sleeve around the injection head does not slide back, no vaccine will be released. This enables a high level of user safety.

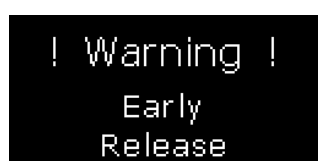

Furthermore, the nozzle sensor measures if the minimum contact time between device and piglet **for administration of the full dose** is fulfilled. If the injector is released too early from the skin of the piglet, implicating an underdose, the device will give an optical warning via red flashing LED bars and a written notification on the display.

9. Vaccination Process



Push the trigger to load the device. The position sensor indicates whether the device is held in the right position.



When the EPIG[®] is held in the right position, the small circle is inside the big circle and the device begins to load. This function helps to reduce the risk of drawing air into the system.



At the first run of a new session or after every restart of the device, the EPIG[®] will be rinsed for three (3) times by pulling the trigger, to flush out remaining rinsing fluid inside the system and to fill the cylinder with vaccine. **No vaccine will be wasted during this procedure** as approximately three (3) doses of liquid fit into the liquid circuit of the device. The display will let you know, once the third and last rinsing cycle is completed. Rinsing is indicated by a **blue light LED**. If you are changing the battery and the changeover between removing the empty battery and inserting the new one takes less than 5 minutes, the rinsing will be skipped as vaccine is already in the device.



After three (3) rinsing cycles, push and hold the trigger to load the device for the first injection. During loading, "Load Device" is displayed.



After loading, the device is ready to vaccinate, which is indicated by a **white flashing LED** and an illustration of walking piglets on the display. At this stage, (a) the first injection cycle can be started, (b) another rinsing cycle can be carried out or (c) the pen counter or vial level indicator can be reset.

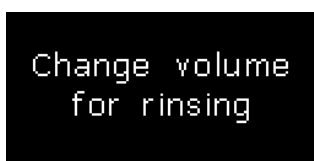

With option (b) above, another rinsing cycle can be carried out by pushing one of the display buttons and **simultaneously** pushing the trigger. If the dose is set to 1 ml, the device will automatically change the volume back to 2 ml for rinsing. If the dose is set to 2 ml, rinsing will be carried out without a change of volume.

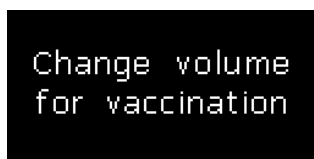

The device will automatically switch back to the set dose after the rinsing cycle, which is indicated by yellow flashing LED bars. This is only relevant when the dose was set to 1 ml prior to rinsing.



For the option (c) above, to reset the pen counter or vial level indicator, push the according display button **without** simultaneously pushing the trigger.

Vaccination
successful...

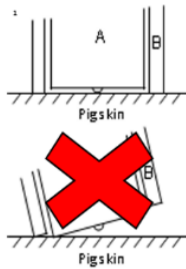

Please release
nozzle

In option (a), an injection cycle is released once the trigger on the handle is **pushed and held** while counter-pressure is generated on the safety sleeve around the injection head (the two-way security mechanism) by applying and pushing the injection head onto the skin of a piglet.

- a) Push and hold trigger on the handle of the device.
- b) Apply the injection head (A) to the skin of the piglet **perpendicularly (!)**, add a certain pressure to make the safety sleeve (B) move backwards and release the injection.
- c) During injection, the display will indicate that the device is currently injecting by showing "Vaccination". The required time per injection is **0.1 sec for 1 ml and 0.2 sec for 2 ml**. During this time, make sure that the nozzle of the device stays pushed onto the skin of the piglet perpendicularly.
- d) The device will indicate that the injection was administered successfully by a **green light LED** and a notification on the display. If the device was removed from the skin of the piglet too early, the device will indicate this by a **red light LED**. Thus, the classification into good or bad injection is based on a time measurement (see point 3 above).
- e) After each injection, release the device from the skin of the piglet to enable the next loading cycle and injection. When kept in contact with the piglet's skin **after** an injection and still reloading, the device will show "Please release Nozzle" before another injection can go into the same piglet by mistake. Additionally, the LED bars will flash white and red in alternation. After releasing the nozzle from the pig, the alternating LED signal will continue to appear, nonetheless you can continue with the next injection.

By keeping the trigger **continuously pushed**, EPIG® automatically prepares itself for the next vaccination. The next pig can now be vaccinated by pushing the nozzle against its skin. Caution: Continuously pressing the trigger results in bypassing the double safety mechanism and the risk for unintentional release of an injection is present.

After administering a vaccination, a small residue of vaccine is visible on the piglet's skin. This is normal with needle-free intramuscular vaccination and does not affect the proper administration of the vaccine.

10. Device Cleaning

10.1. Rinsing

⚠ The cleaning procedure mentioned hereafter should be carried out after **each** vaccination session.

- Leave the battery attached to the device.
- Disconnect the vaccine bottle (vial) (see chapter 5 “Bottle connection / disconnection”).
- To clean the fluid path inside the device (section between bottle attachment and nozzle, shown in picture below), mount a bottle of Isopropanol or a mix of demineralized water and detergent to the device, using the 100ml PET bottle and threaded bottle adaptor supplied. Start the rinsing program by pushing **both display buttons** at the **same time** for 2 seconds. This way, the device will automatically perform ten (10) rinsing cycles in a row without any further action required. This process will start only when the device is held in the right position (pointing slightly downwards), is not loaded and the home screen is shown.



- Disconnect the bottle of Isopropanol or soap solution from the device and connect a bottle of clear demineralized water or PBS (phosphate buffered saline). Start the rinsing program **again** (10 rinsing cycles) to make sure that **all residuals of isopropanol or soap solution are flushed out** of the device. This step will avoid any harm to / chemical reaction with the vaccines attached after cleaning.

10.2. Cleaning of the device

⚠ Prior to cleaning your device from the outside, **remove the battery (!)** at the bottom of the handle.

⚠ For the cleaning of the device, remove the bottle of clear demineralized water or PBS and the used bottle / tubing adapter.

⚠ The below mentioned cleaning procedure should be carried out after **each** vaccination session.

⚠ The device is **splash water resistant** according to IP protection class 54. **Do not immerse the device in any liquid, nor clean under running water.**

Definition of IP54:

The device has complete protection against physical contact (a person cannot touch critical parts), and dust can only enter in small quantities. It is also protected against splash water from all sides.

⚠ Don't use high pressure / steam cleaning devices to clean EPIG®.

- Remove all organic material from the device manually by using disinfection wipes or a **clean, wet towel**.
- Thoroughly clean the thread of all used adapters **and** the thread of the device (a) with disinfection wipes or a clean, wet towel. Residual vaccine can clog the thread and damage it!
- After cleaning, dry the device with a clean paper cloth.



- Unscrew the nozzle and safety sleeve (b) from the device and clean both separately with disinfection wipes.
- Please pay attention to the valve and spring sitting below the nozzle +(see chapter 11.1, step 1) (c).
- Both parts are uncovered and sitting loose on top of the cylinder.
- Remove valve and spring and clean it thoroughly (c)
- Check if the gasket on the valve is free of contaminations and particles (c)
- Reassemble the valve and spring in the correct way (d) and make sure that the spring sits straight.
- Make sure your EPIG® device is **completely dry** before putting it back into the case



11. Troubleshooting

Prior to sending a device to repair, always try below mentioned steps in case of any technical issues with your EPIG® device. In addition, the FAQ section in the EPIG® App provides answers to the most commonly asked questions.

Problem	Cause	Solution
Air detection.	<ul style="list-style-type: none"> - Incorrect handling of the device - winding in the correct position and sudden change of position while still sucking in. - Generally switch off of the position sensor. - Bottle change. - Air in the tube – of course only with tube application. - Cleaning – if the device is not cleaned thoroughly, the spring/valve can become dirty and cause air to enter the system through the front of the nozzle. - Cylinder Service – likewise during cylinder service the spring, valve or O-ring may be placed incorrectly on the cylinder which will have the same effect as the above item cleaning. 	<p>Mount included 100ml PET bottle filled with distilled water and squeeze the bottle during loading to increase suction pressure. If this doesn't help, see separate trouble shooting guide (part of App FAQs).</p> <p>In addition, check the gasket on top of the cylinder as well as the valve below the injection head for contaminations and ensure that spring and valve are positioned correctly. (see 10.2)</p>
Injection is not possible.	Contaminated injection head / jet outlet.	Clean injection head. (see 10.2)
	Malfunctioning cylinder.	Perform Cylinder Service. (see 11.1)
	Application error.	Place injection head perpendicularly on the piglet skin. (see 9)
When cleaning internally, after 10 cycles, little / no rinsing fluid comes out of the injection head.	Air inside the system.	Follow troubleshooting guide for air detection.
	Pump is not working.	Return the EPIG® device to supplier.

	Vial not properly positioned inside the bottle holder.	Remove the vial and re-position it on the spike inside the bottle holder. (see 5.1 and 5.2)
	Contaminated injection head.	Clean injection head. (see 10.2)
The safety sleeve around the injection head remains jammed following vaccination.	Contaminated injection head.	Clean injection head. (see 10.2)
	Possible damage to the injection head or to the safety sleeve.	Release the trigger immediately, remove the battery and perform exchange of injection head using the appropriate spare part (not included). (see 12.1)
A lot of vaccine on the skin of the animal and no puncture visible (as mentioned in chapter 9, it is normal that a small residue of vaccine will remain on the piglet's skin).	Air inside the system.	Rinse the device with rinsing fluid. During the pump process, hold the device horizontally, during the rinsing process, hold the device vertically (pointing upwards). Repeat this procedure 10 times. (see 10.1)
	Contaminated injection head / jet outlet.	Clean injection head. (see 10.2)
It is not possible to unscrew the bottle adaptor from the thread of the device.	Vaccine has leaked into the thread and dried.	Try normal cleaning procedure. Do not try to loosen it with a tong / pipe wrench, because it would break the bottle holder off the device.

Display Indication:

Problem	Cause	Solution
"Cylinder Service"	The service counter records 12,000 shots: a service is required.	Perform Cylinder Service. (see 11.1)
"Low Battery Please Charge"	The battery has to be charged. Vaccination is still possible.	Fit a charged battery into the EPIG® device and recharge the empty one. (see 14.1 and 14.2)
"Load Process"	Weak battery.	Insert a fully charged battery. (see 14.1)
	Cylinder defective.	Perform "Cylinder Service". (see 11.1)
"Air detected"	Air was drawn into the device.	Rinse device at least three (3) times. If this doesn't solve the issue, follow the troubleshooting guide. (see 10.1)
"Please release nozzle"	Contact with piglet after injection was kept upright.	Release device from the piglet.
"Warning! Early Release"	Device was released from the piglet too early.	Revisit vaccination technique. (see 9)

⚠ CAUTION: In case of a necessary return of the device to the manufacturer, please **remove the batteries from the case** (as per dangerous goods regulation of all common forwarders)!

12. Maintenance and Repair

12.1. Cylinder Service

Service of the EPIG® is required after 12,000 injections. When service is due, the message “Service due” will appear on the EPIG® display.

For maintenance, the cylinder needs to be replaced by the included spare cylinder using a 22 mm, a 15 mm wrench and the supplied cylinder assembly tool. Maintenance should be done in a clean environment.

- ⚠ This step-by-step instruction is in addition to the user instructions delivered with the EPIG® device. Please read the user instructions carefully before operating the device and/or performing cylinder service.
- ⚠ Always remove battery before doing the cylinder service!
- ⚠ Make sure, that no bottle with rinsing/cleaning fluid is placed in the bottle holder of the device.

Step 1: Unscrew injection head

- Place the device on a solid surface in the recommended position (1).
- Carefully unscrew the injection head with a 22 mm wrench (1).
- If the wrench does not hold the injection head properly, rotate the safety cylinder slightly.
- Remove injection head (incl. safety sleeve) and spring(2).
- Remove the valve (valve body and spring) (3).
- ⚠ As soon as injection head and valve are dismantled: Ensure that the exposed tip of the EPIG® is protected from dirt (4).
- ⚠ Hold the device with the head facing downwards in order to drain residues of vaccine or rinsing fluid (5).

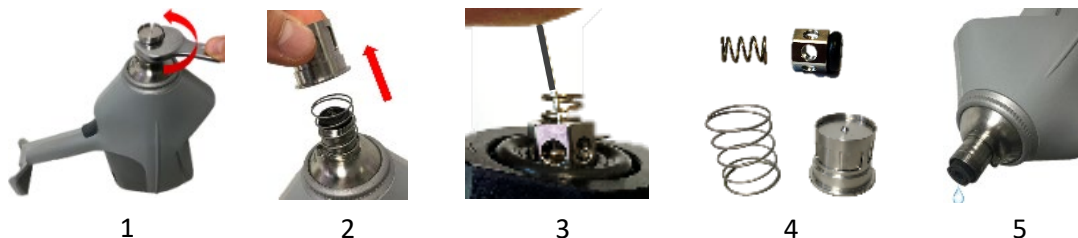

Step 2: Remove old cylinder

- Unscrew the old cylinder with a 15mm wrench (6).
- Hold the device with the head facing downwards (7) and only then (!) remove the cylinder from the device by pulling. This will allow you to drain remaining vaccine or rinsing fluid.



Step 3: Lubricate the piston rod

- Prior to lubrication, clean the piston chamber and piston rod by wiping it with a clean cotton cloth or clean Q-tip/cotton bud (8).
- Lubricate the tip of the piston rod using a fingertip or Q-tip/cotton bud soaked in the supplied white oil.



8

Step 4: Insert new cylinder

- Lubricate the o-rings (9) on the exterior wall of the new cylinder with white oil.
- Insert the new cylinder into the opening of the piston chamber and push down until it sits firmly (10).
- Remove the protection cap (11) taking care that the spring, o-ring and valve below the protection cap will stay in place.
- Push the new cylinder down (with your finger) until the thread engages. Then tighten the cylinder with the supplied cylinder assembly tool (13) until you feel a significantly increased screwing resistance (12). Alternatively use a torque wrench set to 1.8 nm.



9



10



11



12

13

Step 5: Tighten the injection head

- Put the large spring in between the front part of the device and the injection head (14).
- Clean (!) the injection head and then carefully tighten it with the safety sleeve over it (15), until you feel a significantly increased screwing resistance, by using a 22 mm wrench (16) and pushing the injection head down until the thread will engage.



14



15



16

Step 6: Check the injection head

- Check if the injection head is sitting correctly and if the safety cylinder around the injection head (marked yellow) is moving smoothly (17).

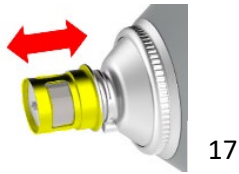

17

Step 7: Flush & shoot

- Fit a bottle with rinsing/cleaning fluid into the holder and rinse until a clean and continuous jet is coming out of the injection head. (Use rinsing program, see 10.1)
- Simulate 10 injection cycles by shooting into a clean towel. This optimally aligns the valve and the spring.

Step 8: Check functionality

- If the injection head is not operating properly (no clean and continuous jet of rinsing fluid is coming out), please repeat cylinder service by exactly following above mentioned steps.

Step 9: Reset Service Counter

- After successful completion of cylinder service, please reset service counter.
- Starting from the home screen, push the right button three times until reaching menu point "Service Counter" (18).
- Push button "Reset" for at least 3 seconds.
- The counter returns to "0".

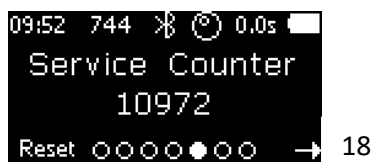

18

12.2. EPIG® App

The EPIG® App is an essential part of the device. It supports the on-farm service concept.

QR Codes:



The EPIG® App has three major functionalities:

- 1) Device Management
 - a. Language settings
 - b. User manual / FAQs
 - c. Counter readings
 - d. Device check
- 2) Vaccination Management
 - a. Vaccination Compliance
 - b. Vaccination Events
 - c. Vaccination Settings
- 3) Support Request
 - a. User manual / FAQs
 - b. Repairs
 - c. Direct contact to Henke-Sass, Wolf

To learn more on what sort of failure occurred, download the EPIG® App for iOS or Android. Run a self-diagnosis by starting the App, connecting the App to your device and thereafter pushing the button “Run diagnosis” in the App.

12.3. Maintenance and repair service

For certain problem reports resulting from a device check run via app (see above 11.2, 1d and 3b), maintenance or repair in an approved service point is necessary. Also, the EPIG® device will show the message “Factory Service” on its display. The EPIG® device has to be sent to an approved service point. Details can be found in the table on the following page. Please contact Henke-Sass, Wolf to arrange the return of the device and **fill out the supplied return form**.

⚠ CAUTION: In case of a necessary return of the device to the manufacturer, please **remove the batteries from the case** (as per dangerous goods regulation of all common forwarders)!

Defect	Action sequence	Action	Service Point
Display button		Replacement of Display button	Henke-Sass, Wolf
Display	1	Please contact your local distributor	Farm / User
	2	Replacement of Display	Henke-Sass, Wolf
Nozzle Sensor	1	Cylinder Service + Replacement of safety sleeve around injection head	Farm / User

	2	Replacement of Nozzle Sensor (if sensor itself is defective)	Henke-Sass, Wolf
Trigger		Replacement of Trigger	Henke-Sass, Wolf
Battery	1	Charge battery (100%)	Farm / User
	2	Use second battery and compare performances (indicates whether the defect is caused by the battery or the device itself)	Farm / User
	3	New battery (available as spare part)	Farm / User
Charger		New charger (available as spare part)	Farm / User
Air detection	1	Mount included 100ml PET bottle filled with distilled water and squeeze the bottle during loading to increase suction pressure. If this doesn't help, consult trouble shooting guide.	Farm / User
	2	Cylinder service	Farm / User
	3	If both doesn't help, please contact your local distributor.	Farm / User
Position sensor	1	Optionally, use device without position sensor (only if used with tubing setup)	Farm / User
	2	Replacement of position sensor	Henke-Sass, Wolf
Bluetooth	1	Restart device and check if Bluetooth works now	Farm / User
	2	Try to connect with a different mobile phone	Farm / User
	3	Replacement of Bluetooth module	Henke-Sass, Wolf
Device storage		Repair	Henke-Sass, Wolf
Motor		Repair	Henke-Sass, Wolf
Ambient Light Sensor	1	Optionally, use device without ambient light sensor	Farm / User
	2	Replacement of ambient light sensor	Henke-Sass, Wolf
LED (complete or single colors)	1	Optionally, use device without LED functions	Farm / User
	2	Repair of LED	Henke-Sass, Wolf

NOTE: Repair or maintenance by unauthorized persons will lead to a loss of warranty!

- ⚠ Unauthorized opening of EPIG® devices or battery packs may cause harm and is not allowed!
- ⚠ All works on the electrical system may only be carried out by qualified electricians of the manufacturer.

13. Dismantling

The EPIG® device may only be dismantled by authorized service engineers. In case of unauthorized dismantling, the device will lose its warranty.

- ⚠ Do not open the EPIG® device by yourself due to health and safety risks!

14. The battery and the charger

14.1. Battery

The battery of the EPIG® is a rechargeable Lithium Ion (Li-Ion) battery. At least 1,000 injections can be administered by using a fully functioning and charged battery.

The battery should be slotted into the opening in the base of the EPIG® device:



A fastening button will hold the battery in position. The battery can be removed from the base by pushing down the button at the front of the battery and by pulling out the battery.



- ⚠ Use only appropriate batteries in the EPIG®. The use of other batteries can lead to injuries and fire hazard.
- ⚠ Do not expose the battery to mechanical shocks.
- ⚠ Stop using the battery if it becomes abnormally hot, or if discoloration, deformation or abnormal conditions are detected during use, charge or storage.
- ⚠ Replace the battery when its running time between charges becomes much shorter than usual.
- ⚠ It is recommended that batteries are not recharged before falling below 50% loading capacity.
- ⚠ Never store empty batteries as this could damage them and make them unusable.
- ⚠ Never send/ ship defective batteries to any destination. Instead, please dispose of them correctly.

14.2. Charger

Charge the battery using only the charger supplied. Connect the battery to the charger and connect the charger to an electric socket. When connected correctly, the charging process will start automatically.

- ⚠ Check the charger regularly for damage, especially the connection cable and the housing. Do not use damaged battery chargers.
- ⚠ Always grasp the plug, not the cable, when removing the mains plug from the socket.
- ⚠ Faulty electrical installation or too high mains voltage can lead to electric shock. Only connect the battery charger to an easily accessible socket, so that you can quickly disconnect it from the power supply in the event of fault.
- ⚠ If you charge the battery improperly, the battery, battery charger and the EPIG® device may be damaged. Charge the battery at an ambient temperature between 0°C and 45°C.

The LEDs have the following functions:

<p>LED lights orange: Battery is empty and charging.</p>	
<p>LED lights yellow: Battery is partly charged and still charging.</p>	
<p>LED lights green: Battery is fully charged.</p>	

- ⚠ The battery charger is not waterproof!
- ⚠ Operate the battery charger indoors only!

15. Technical Specifications

EPIG® Device

Model: 101

Weight: 2200 g

Dimensions: 304 x 107 x 348 mm (incl. battery)

Battery

Voltage: 10.8 VDC

Capacity: 3120mAh (33.7Wh)

Type: Lithium-Ion rechargeable Cell

Weight: 242 g

Charger

Protection Class: 2

Type: Lithium-Ion battery charger

Input Voltage: 100-240 VAC, 50-60 Hz

Input Current: max 0.9 A

Compliance statements

CE EU declaration: AMB2621

FCC ID: R7TAMB2621

Certification Number: 5136A-AMB2621

16. Disposal

The EPIG® device, batteries, accessories and packaging should be sorted for environment-friendly recycling.

Do not dispose of power tools and batteries/rechargeable batteries into household waste!

Applicable in the EU

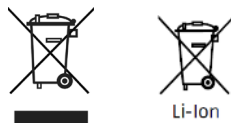

Old appliances must not be disposed of with household waste!

Batteries and rechargeable batteries must not be disposed of with household waste!

According to the European Guideline 2012/19/EU, power tools that are no longer usable, and according to the European Guideline 2006/66/EC, defective or used battery packs/batteries, must be collected separately and disposed of in an environmentally correct manner.

17. EC declaration

	Konformitätserklärung / Declaration of Conformity	Seite / Page 1 von 1	
		Produktgruppe / Product group: EPIG®	
		Revisionsstand / Revision status: --	Revisions-Datum / Revision date: 13.05.2020
Alle Rechte vorbehalten. Ausgabe als Drücke nur mit Genehmigung von GLEUGM. All rights reserved. Copies for third parties only by permission of GLEUGM. Tous droits réservés. Ces copies à des tiers seulement avec la permission de GLEUGM.			

Wir, die HENKE-SASS, WOLF GmbH, Keltenstrasse 1, 78532 Tuttlingen erklären in alleiniger Verantwortung, die Übereinstimmung mit den folgenden Richtlinien:

- EMV-Richtlinie 2014/30/EU
- Maschinenrichtlinie 2006/42/EG
- Richtlinie 2011/65/EU zur Beschränkung der Verwendung bestimmter gefährlicher Stoffe in Elektro- und Elektronikgeräten

We, the HENKE-SASS, WOLF GmbH, Keltenstrasse 1, 78532 Tuttlingen declare in our own responsibility the conformity to following directives:

- EMC-Directive 2014/30/EU
- Machinery Directive 2006/42/EG
- Directive 2011/65/EU on the restriction of the use of certain hazardous substances in electrical and electronic equipment

Diese Konformitätserklärung ist gültig für folgende Produkte:

This Declaration of Conformity is valid for following Products:

EPIG®

Die Produkte stimmen mit folgenden Normen überein:

The products are conforming to following standards:

EN ISO 12100:2010; DIN EN 55032:2016; DIN EN 61000-4-2:2009; DIN EN 61000-4-3:2011; DIN EN 61000-4-8; 2010

Für das Ladegerät/ For the charger: IEC 60335-2-29:2002 +A1:2004 +A2:2009; EN 61000-6-3:2007 + A1:2011; IEC 61000-6-1:2016

Diese Konformitätserklärung ist gültig bis 30.04.2025.

This Declaration of Conformity is valid until 30.04.2025.

Tuttlingen, den 13.05.2020

Ort und Datum der Ausstellung
Place and Date of issue



Dr. Oliver Bartl
Geschäftsleitung
Chief Executive Officer

HENKE-SASS, WOLF GMBH
Keltenstraße 1
78532 TUTTLINGEN
GERMANY
Tel. +49(0)7462/9466-0 · Fax 9466-5000

Firmenstempel
Company Stamp